



























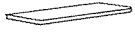

この度は、当社の商品をお買い上げ頂きまして、誠にありがとうございます。この商品を永く安全にご使用いただくために、この取り扱い、組み立て説明書をよくお読みいただき内容をよくご理解の上で、正しく組立て、ご使用いただけるようお願いします。また取り扱い、組立て説明書は、必要に応じていつでも見られるよう、大切に保管してください。

部品一覧

- | | | | |
|--|---|--|--|
| <p>A</p> <p>ボルト M6 X 20mm</p>  <p>12 PCS</p> | <p>B</p> <p>スプリングワッシャーM6</p>  <p>12 PCS</p> | <p>C</p> <p>ワッシャー M6</p>  <p>20 PCS</p> | <p>D</p> <p>ボルト M6 X 40mm</p>  <p>2 PCS</p> |
| <p>E</p> <p>ボルト M6 X 60mm</p>  <p>6 PCS</p> | <p>F</p> <p>ボルト M6 X 50mm</p>  <p>1 PC</p> | <p>G</p> <p>ボルト M6 X 30mm</p>  <p>15 PCS</p> | <p>H</p> <p>ボルト M6 X 12mm</p>  <p>12 PCS</p> |
| <p>I</p> <p>六角レンチ M4</p>  <p>2 PCS</p> | <p>組み立てる前に、部品の数を確認してからはじめてください。</p> | | |

部品一覧

- | | | | | |
|---|--|--|---|--|
| <p>1</p> <p>ヘッドボード</p>  <p>1 PC</p> | <p>2</p> <p>フットボード</p>  <p>1 PC</p> | <p>3</p> <p>左 サイドフレーム</p>  <p>1 PC</p> | <p>4</p> <p>補強バー</p>  <p>1 PC</p> | <p>5</p> <p>右 サイドフレーム</p>  <p>1 PC</p> |
| <p>6</p> <p>床板用パイプ</p>  <p>1 PC</p> | <p>7</p> <p>床板</p>  <p>2 PCS</p> | <p>8</p> <p>ハンガーパイプ</p>  <p>1 PC</p> | <p>9</p> <p>角パイプ (長)</p>  <p>1 PC</p> | <p>10</p> <p>角パイプ (短)</p>  <p>1 PC</p> |
| <p>11</p> <p>メッシュ</p>  <p>1 PC</p> | <p>12</p> <p>シェルフ用パイプ (右)</p>  <p>1 PC</p> | <p>13</p> <p>シェルフ用パイプ (左)</p>  <p>1 PC</p> | <p>14</p> <p>棚板</p>  <p>2 PCS</p> | <p>15</p> <p>丸パイプ</p>  <p>2 PCS</p> |
| <p>16</p> <p>デスク用パイプ</p>  <p>2 PCS</p> | <p>17</p> <p>デスク天板</p>  <p>1 PC</p> | <p>18</p> <p>補強パイプ</p>  <p>2 PCS</p> | <p>19</p> <p>はしご</p>  <p>1 PC</p> | <p>組み立てる前に、部品の数を確認してからはじめてください。</p> |

ねじの締めかた

ねじは最初からきつく締めない

●最初からねじをきつく締めるると他のねじ穴の位置が合わず、組み立てできません。また、全体の歪みの原因になります。

1 すべてのねじを 8割くらいに仮締めする

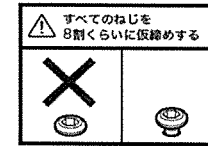

2 最後にすべてのねじをしっかりと締め付ける

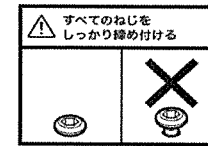

敷物を敷いて組み立てる

●床面保護のため、本体の下に下記のような敷物を敷いてください。
 ・厚手の布
 ・梱包用ダンボールなど

販売元 株式会社 ニトリ

住 所 東京都 北区 神谷3丁目6番20号

商品に関するお問い合わせは、お近くのニトリ各店舗にて承ります。

完成図

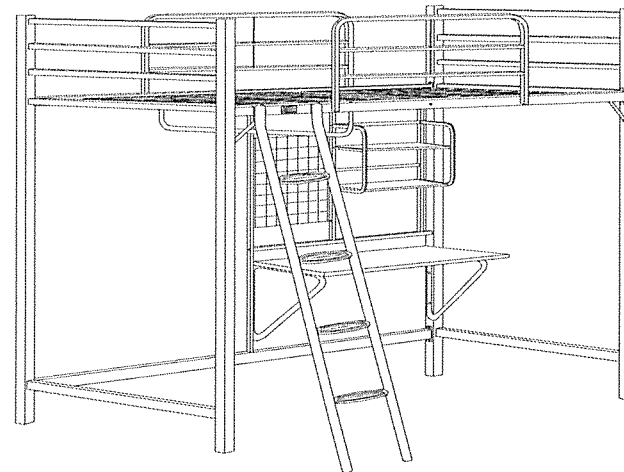

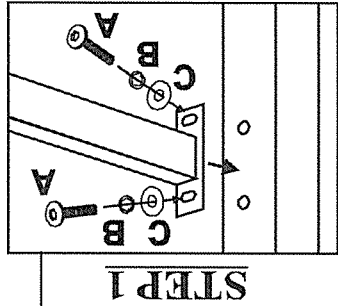

STEP 1

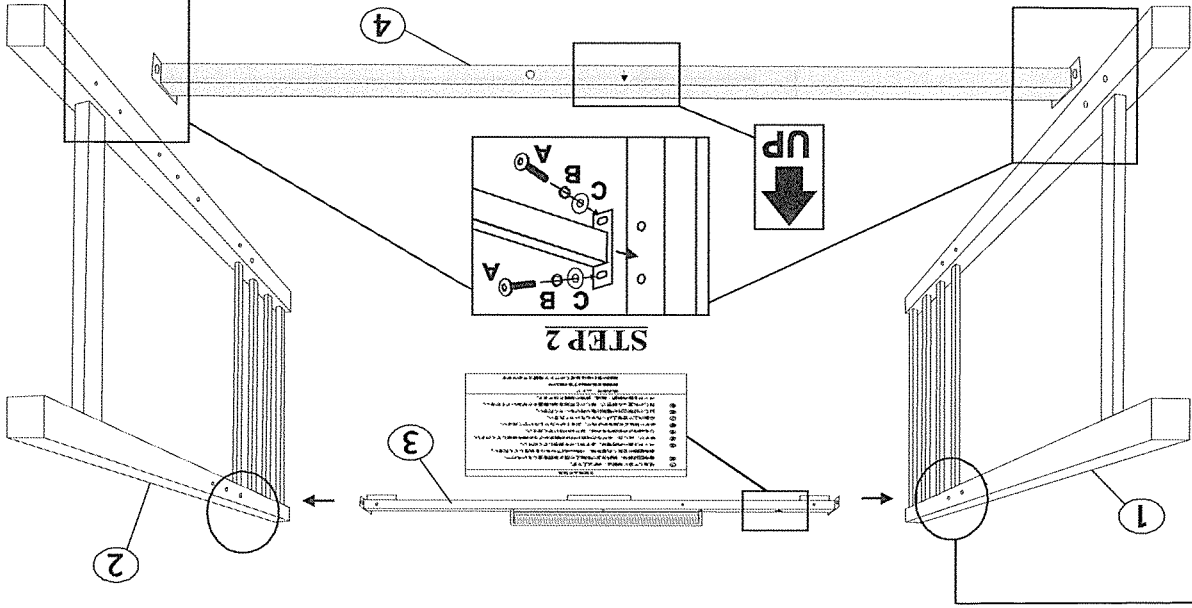

STEP 2

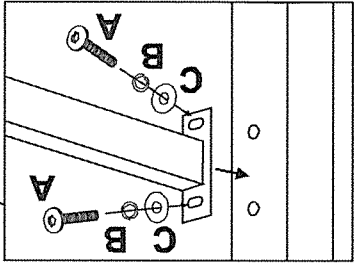
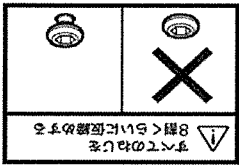

STEP 3

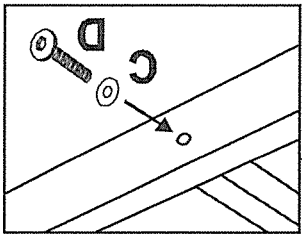

STEP 4

A	ネルト M6 X 20mm = 4PCS
B	スリッパネルト-M6 = 4PCS
C	ワッシャー-M6 = 6PCS
D	ネルト M6 X 40mm = 2PCS

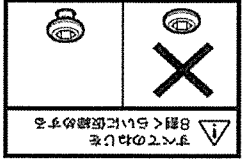

A	ネルト M6 X 20mm = 8PCS
B	スリッパネルト-M6 = 8PCS
C	ワッシャー-M6 = 8PCS

STEP 5

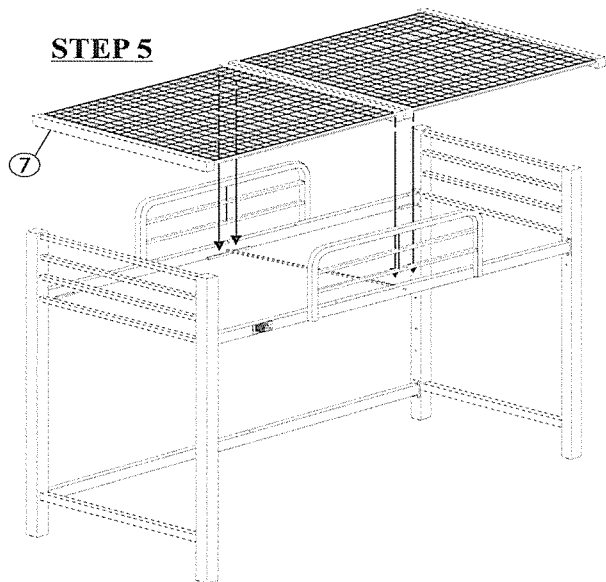

床板の角パイプについているピンを
サイドフレームの穴に差し込んでください。

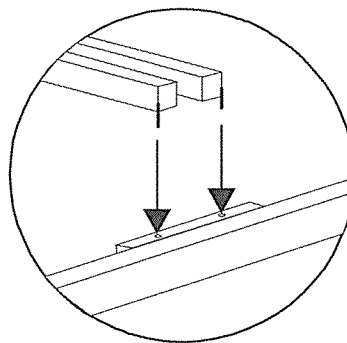

STEP 6

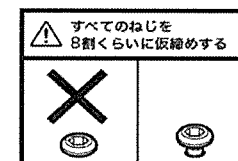
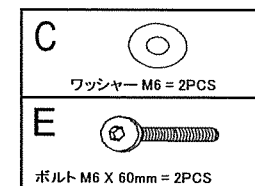
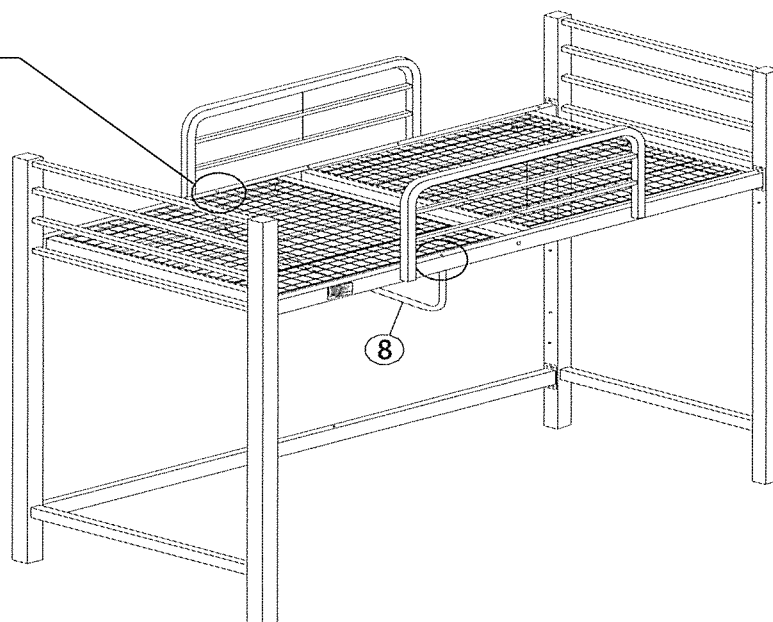
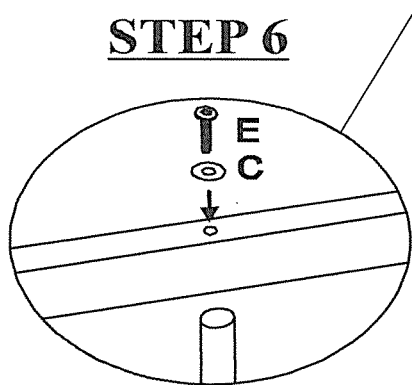

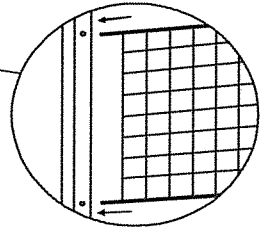

STEP 9b

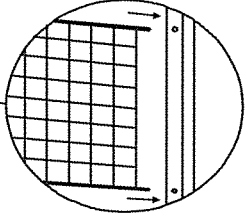

STEP 9a

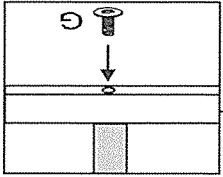
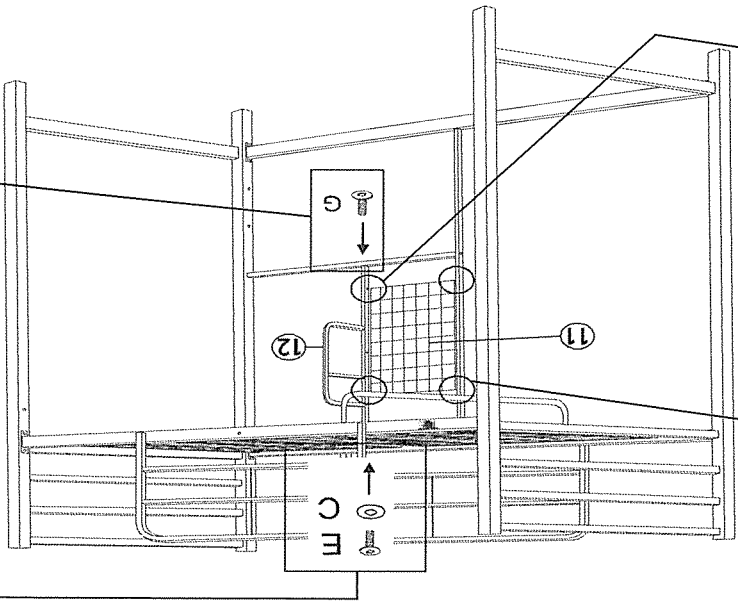

STEP 10b

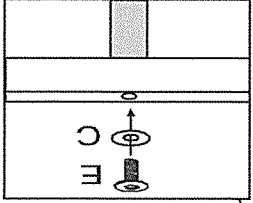

STEP 10a

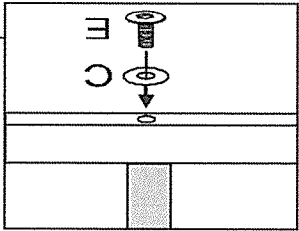

STEP 7b

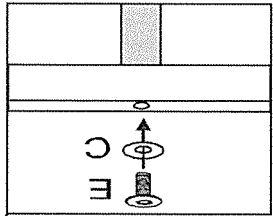

STEP 7a

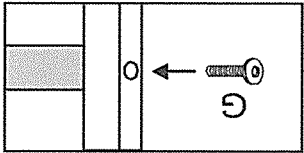
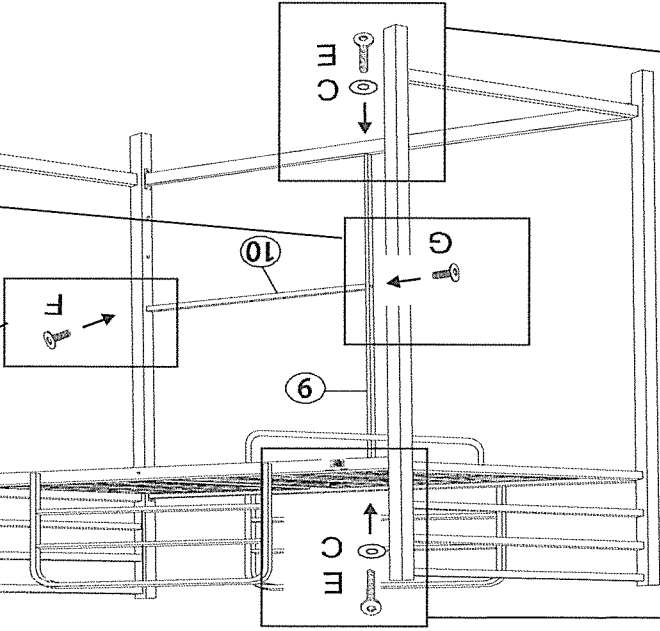

STEP 8b

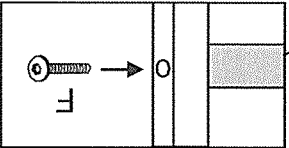

STEP 8a

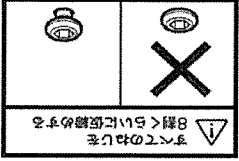

△ 反対のねじを
8割くらいは仮締めする

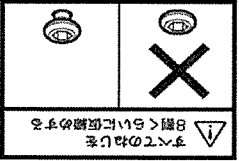

△ 反対のねじを
8割くらいは仮締めする

C	ワッシャー-M6 = 1PC
E	ボルト M6 X 60mm = 1PC
G	ボルト M6 X 30mm = 1PC

C	ワッシャー-M6 = 2PCS
E	ボルト M6 X 60mm = 2PCS
F	ボルト M6 X 50mm = 1PC
G	ボルト M6 X 30mm = 1PC

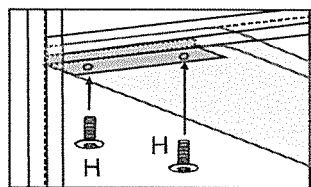

STEP 12

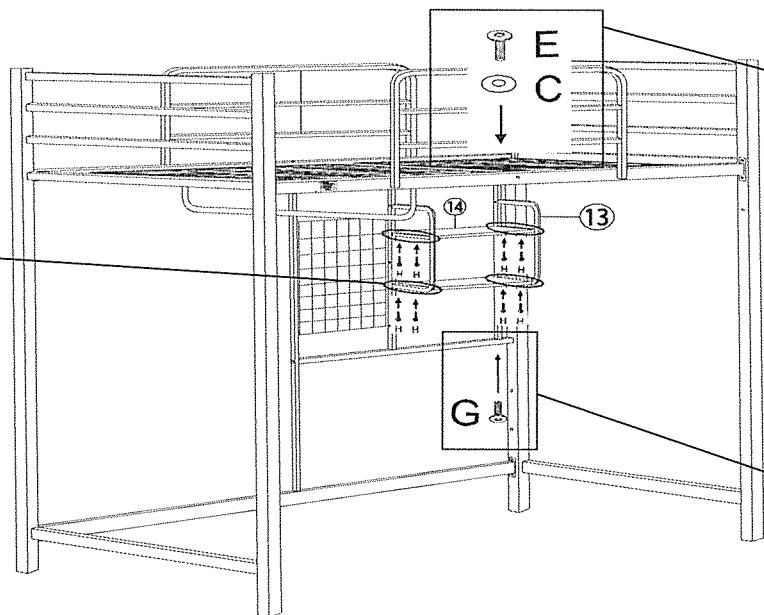



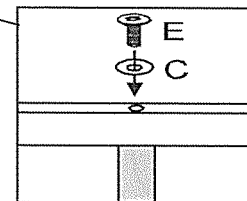

STEP 11a

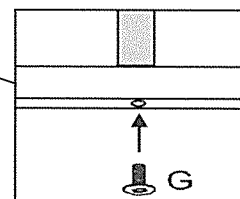

STEP 11b



- C** 
ワッシャー M6 = 1PC
- E** 
ボルト M6 X 60mm = 1PC
- G** 
ボルト M6 X 30mm = 1PC
- H** 
ボルト M6 X 12mm = 8PCS

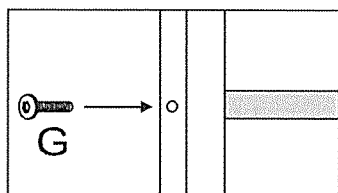

STEP 13

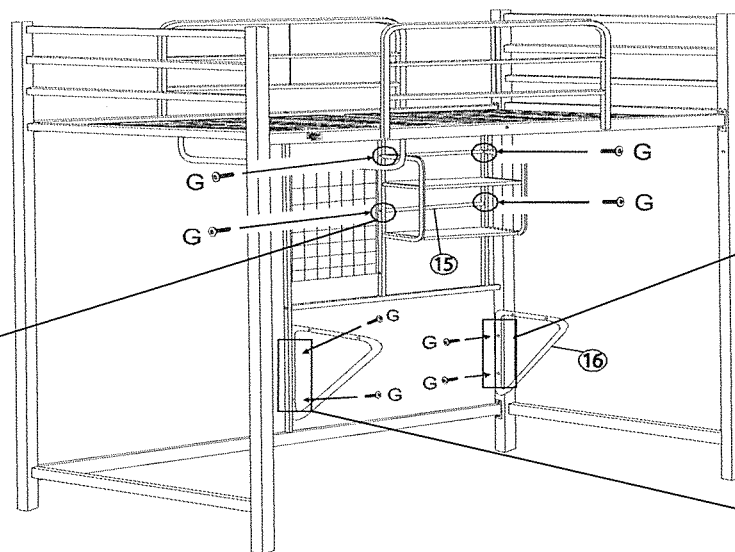

STEP 14b

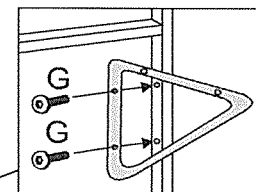

STEP 14a

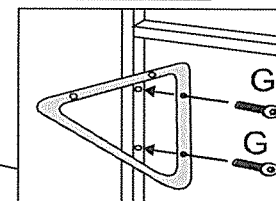

- G** 
ボルト M6 X 30mm = 8PCS

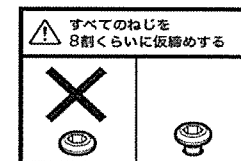

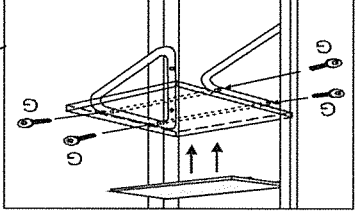
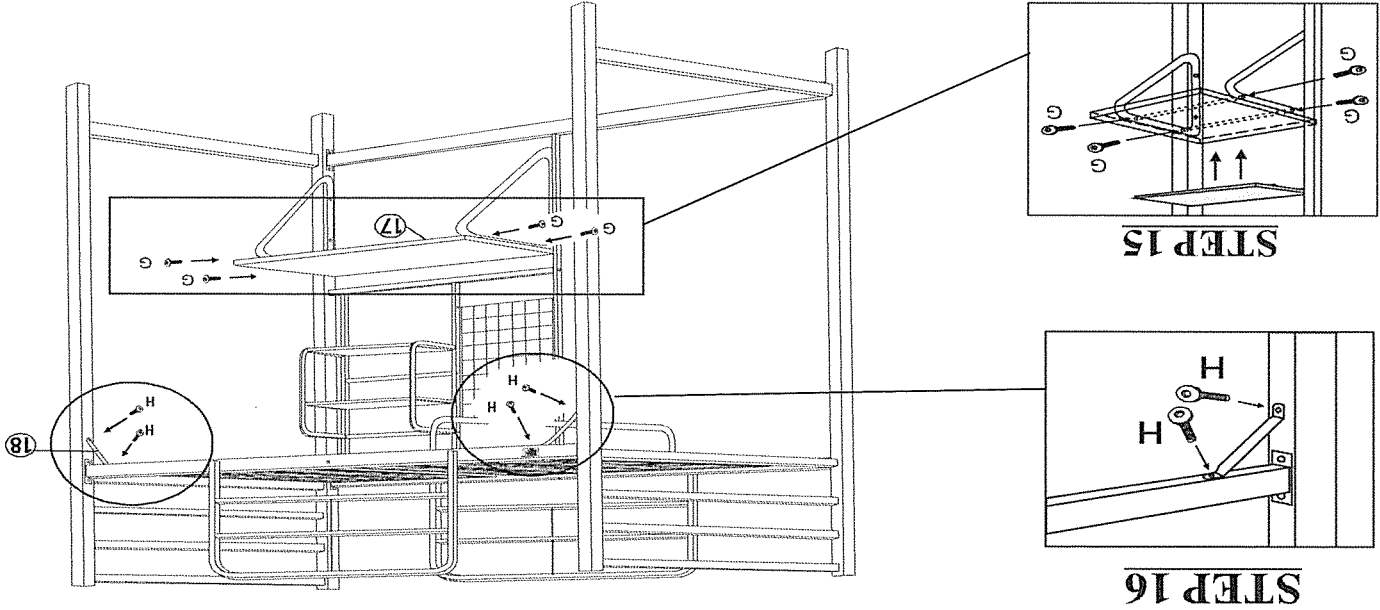

STEP 15

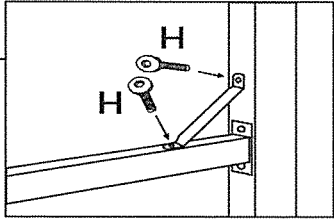

STEP 16

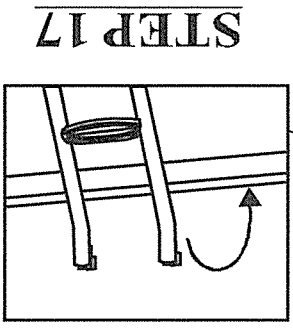

STEP 17

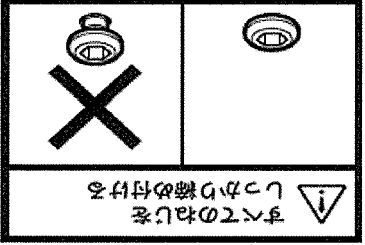
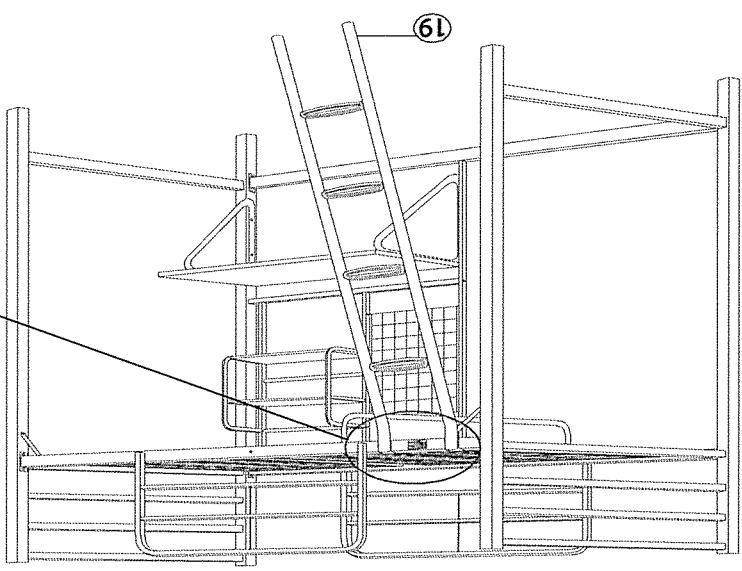

ネジ H M6 X 12mm = 4PCS



H

ネジ G M6 X 30mm = 4PCS



G