





組立説明書

商品名: MIDDLE SHELE LUFFY2-80

商品リスト

A		ネジ 6 x 25 (mm)	8
B		六角レンチ	1
C		脚	2
D		ネジ(予備パーツ)	1

組み立てる前に、部品の数量を確認してからはじめてください。

完成図

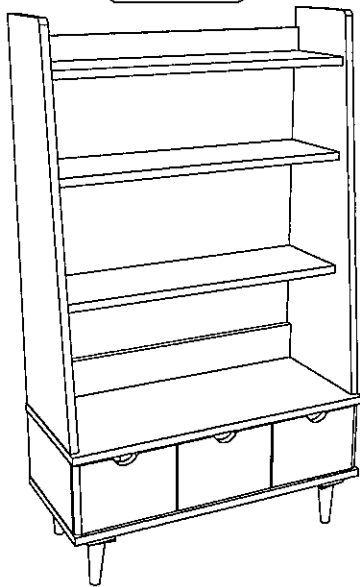

step 1

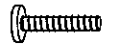
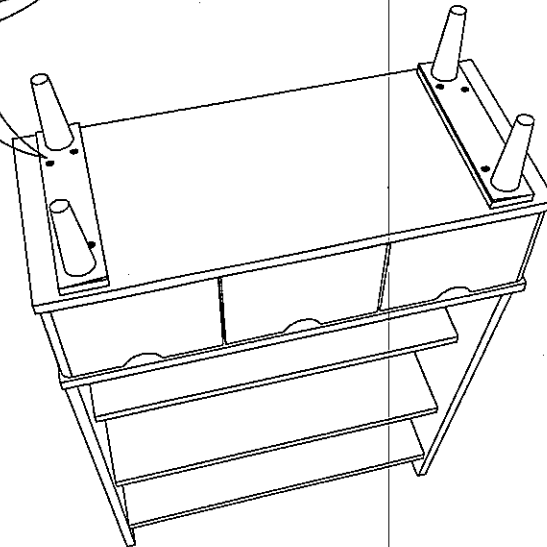
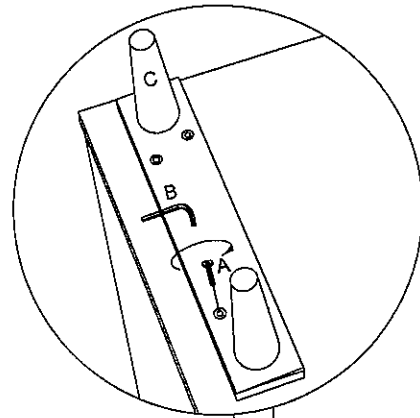

A * 8



B * 1



C * 2

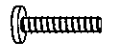

D * 1