

LINE UP

35cm
13.8inch

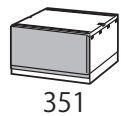

351

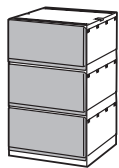

353

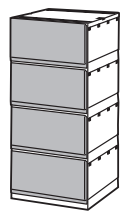

354

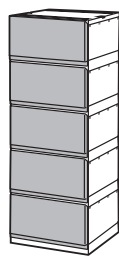

355

52cm
20.5inch

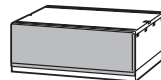

521

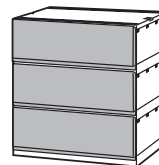

523

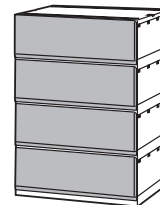

524

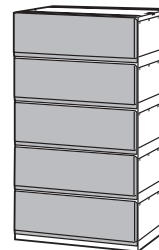

525

① Drawer cover
前面カバー

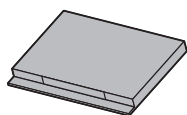

② Drawer
引き出し

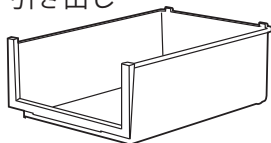

③ Frame
フレーム

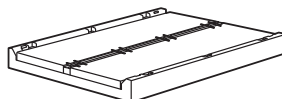

④ Top panel
天板

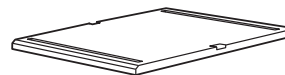

⑤ Non-slip stopper
滑り止め



... 353 or 523 : X3, 354 or 524 : X4, 355 or 525 : X5

... x1

... 1set (2pcs)

1

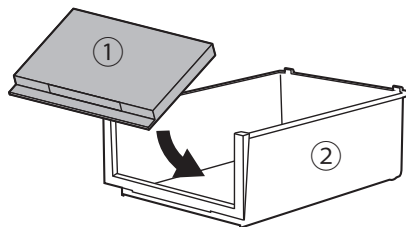

Front view
前から見た図

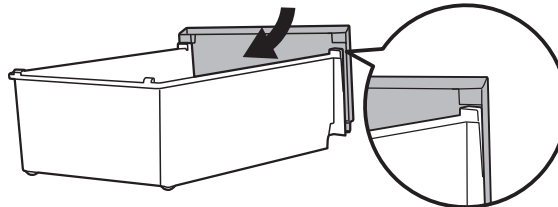

Back view
後ろから見た図



Side view
横から見た図

2

PUSH 押す

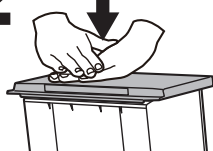

PUSH 押す



3

PUSH 押す

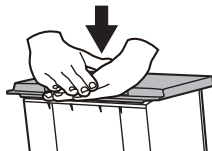

PUSH 押す



CHECK チェック

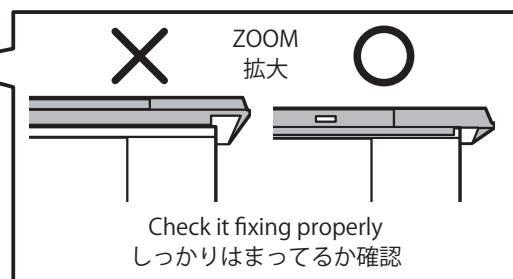
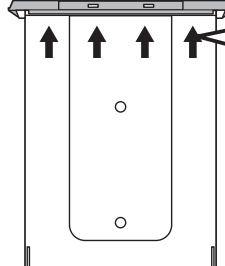

Check it fixing properly
しっかりはまっているか確認

4

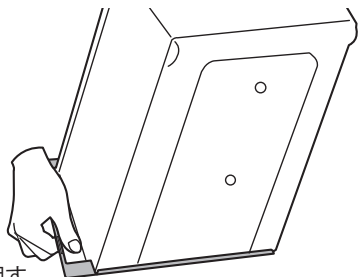

PUSH 押す

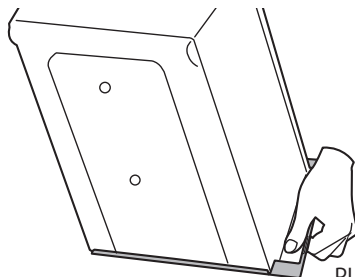

PUSH 押す

OK

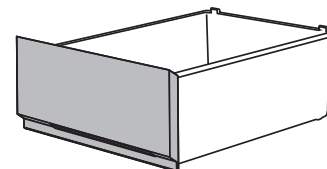

5

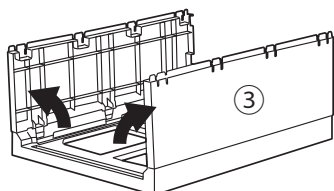

6

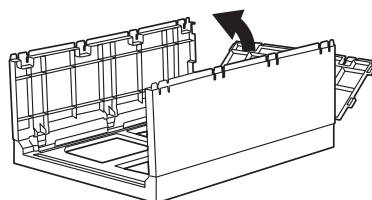

7

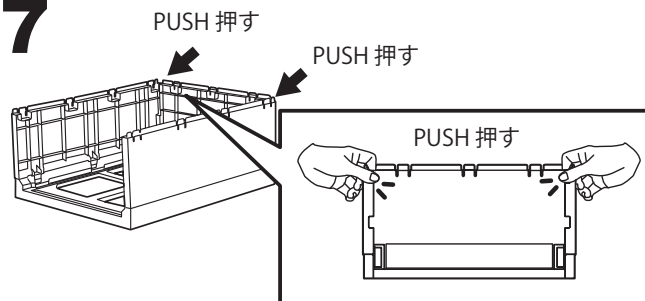

353 or 523 : X3

354 or 524 : X4

355 or 525 : X5

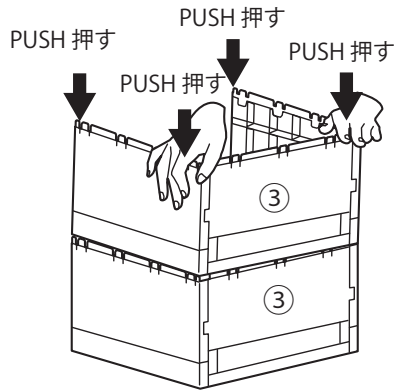
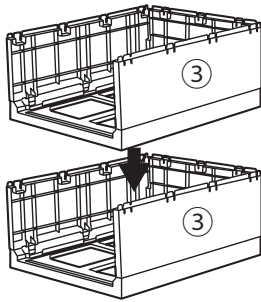

8

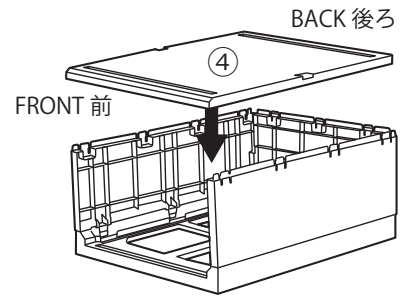

POINT

FRONT 前 BACK 後ろ
Side view 横から見た図

9

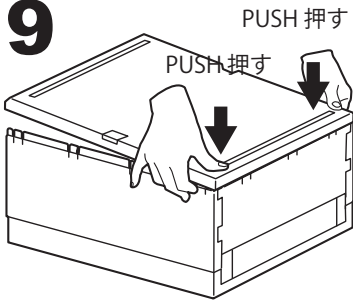

10

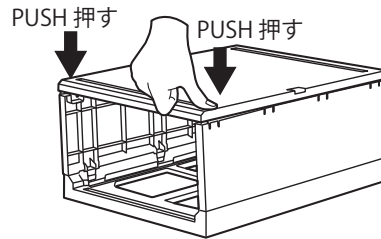

11

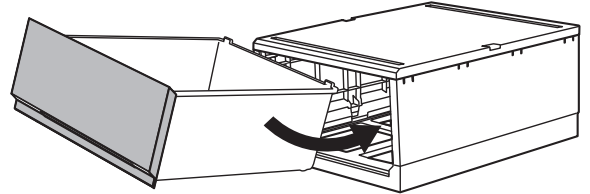

12

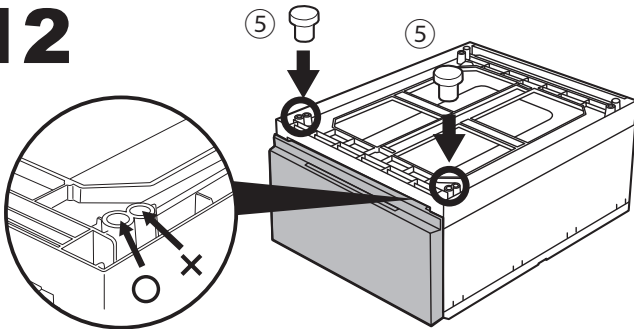

Completion

できあがり

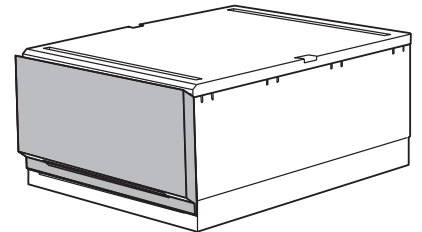

How to remove top panel and frame

天板とフレームの取り外し方

※Helpful for changing the layer.
※段数を変えるときなどにお役立てください。

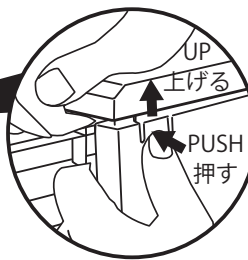
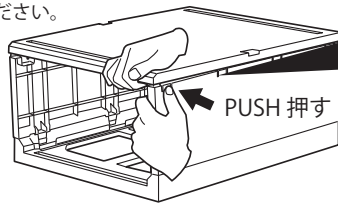

Point of removing
取り外し箇所

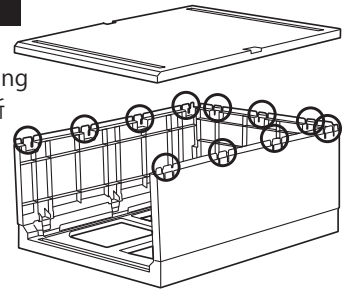

Option : Connective function

連結機能

1.

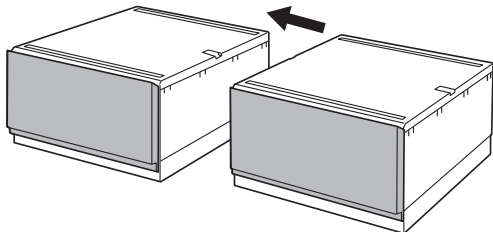

2.

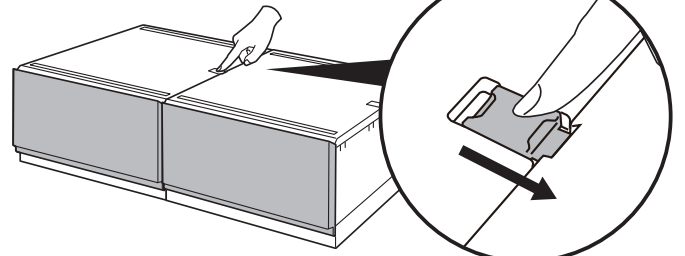

Precautions

- It might be damaged when polish it with scrubbing brush or polishing powder.
- Keep it away from the heat, humidity and direct sunlight.
- Use only for intended purpose.
- Please put things in the product from down layer at first. It is not stable if you put things in only upper layer. There is the risk that the product in itself falls down.

使用上の注意

- たわし又はミガキ粉で磨くと傷がつく恐れがあります。
- 直射日光の当たる場所、火のそばには置かないでください。
- 正規の用途以外には使わないでください。
- 中に物を入れる際、下段から入れてください。上段にだけ物を入れると安定せず、倒れる危険があります。